

CO₂
CO2ST

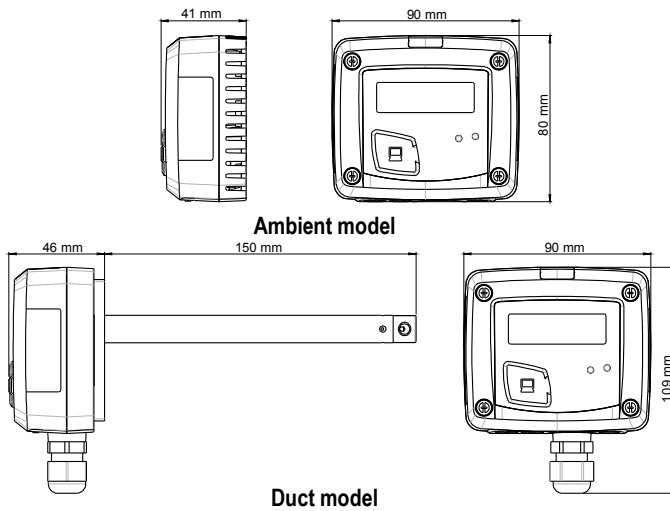

- 0 ~ 5000ppm
- RCR 3A/230 Vac, 24 Vac/Vdc
- LED
- ABS V0, IP65(), 가
- "¼ turn" system mounting with wall-mount plate
-



: ABS V0 as per UL94

:
- duct model : IP65
- ambient model : IP20

: LCD 10 digits. Dimensions : 50 x 17 mm

Height of digits : Values : 10 mm ; Units : 5 mm

() for cables Ø 8 mm maximum

: 138 g (ambient model) ; 150 g (duct model)

	ppm
	From 0 to 5000 ppm
	±3 % of reading ±50 ppm
	Infra-red sensor
	T63 = 30 s
	1 ppm
	Air and neutral gases
	From 0 to +50 °C
	From -10 to +70 °C

*All the accuracies indicated in this technical datasheet were stated in laboratory conditions, and can be guaranteed for measurements carried out in the same conditions, or carried out with calibration compensation.

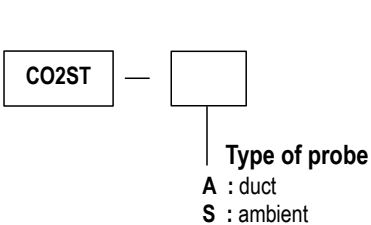

Example : CO2ST-A
CO₂

	1 RCR relay 3 A / 230 Vac
	24 Vac/Vdc $\pm 10\%$
	2 VA
/	Red led in front and internal buzzer
	EN61326
	Terminal block for cables $\varnothing 0.05$ to 2.5 mm^2
PC	USB-mini Din Kimo cable
	Air and neutral gases

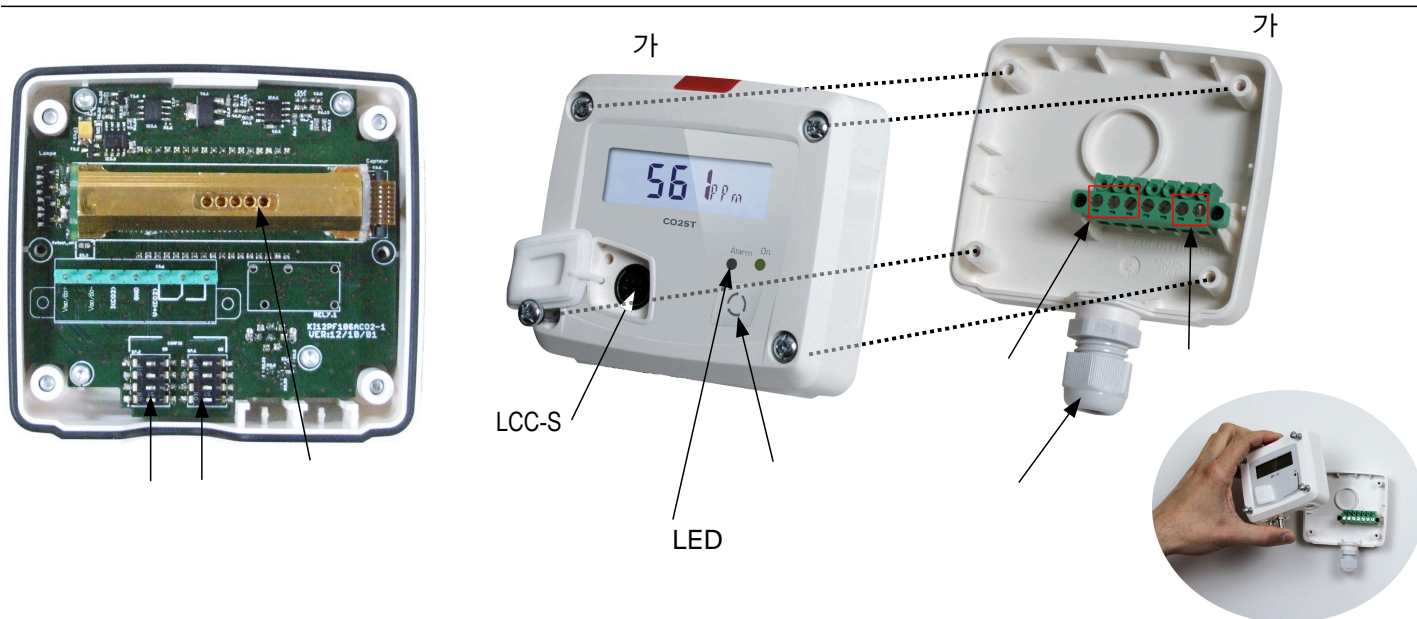

- NFC15-100 standard



가 ,

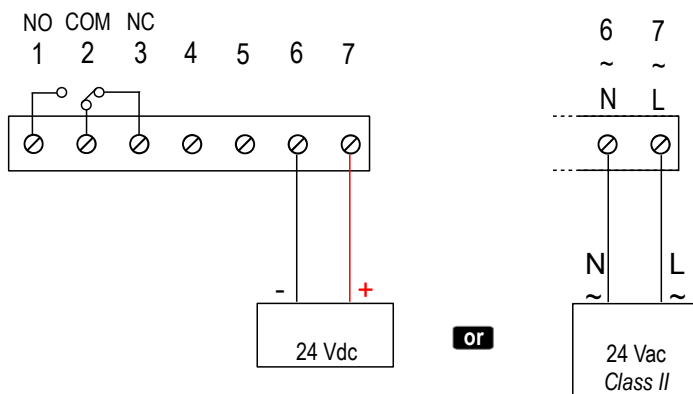

> Thresholds configuration

The button  allows to activate or not an alarm (threshold), to set the action of the alarm (edge), to set the threshold(s) value, to set the time-delay and to acknowledge the alarm.

Working principle :

- By pressing on the button more than 3 seconds, you can validate the setting and go to the next setting.
- By pressing quickly on the button, you can increment a value and scroll down the different option or values.

Setting procedure :

- **Activate or deactivate an alarm :**
 - > Press on the button for 3 seconds, "CONF" is displayed then "NEG", meaning that the relay is in negative security, it is excited during an alarm condition.
 - > If needed, press quickly on the button to switch the relay in positive security, the relay is de-energized during an alarm condition or a current breaking, "POS" is displayed.

- > Press 3 s on the button, “**Buzz**” screen is displayed with “**ON**” or “**OFF**” blinking. Briefly press on the button to activate (“**ON**”) or deactivate (“**OFF**”) (according to the last saved configuration) the buzzer during an alarm condition.
- > Press 3 s on the button, “**Alarm**” screen is displayed with “**On**” or “**Off**” blinking (according to the last saved configuration).
- > Press quickly on the button, the display changes from “**On**” (activated alarm) to “**Off**” (deactivated alarm).
- > Press 3 seconds on the button to confirm the setting. If the alarm is deactivated, the instrument displays the measurement ; if the alarm is activated, the instrument displays the following setting.

• **Set the action of the alarm (rising edge or falling edge)**

The edge determines the action of the alarm according to the trespassing direction of the threshold(s).

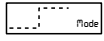

Rising edge (1 threshold) : the alarm goes off when the measurement **exceeds** the threshold and stops when it is **below** the threshold.

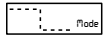

Falling edge (1 threshold) : the alarm goes off when the measurement is **below** the threshold and stops when it **exceeds** the threshold.

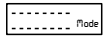

Monitoring (2 thresholds) : the alarm goes off when the measurement is outside the defined low and high thresholds.

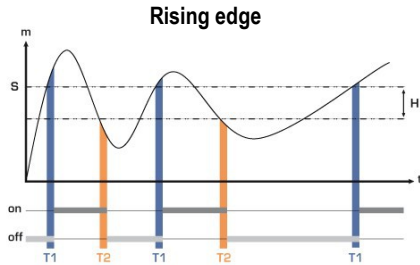

Measurement (m) > Threshold (S) during the time-delay T1 → Alarm activation.

Measurement (m) < Threshold (S) - Hysteresis (H) during the time-delay T2 → Alarm deactivation.

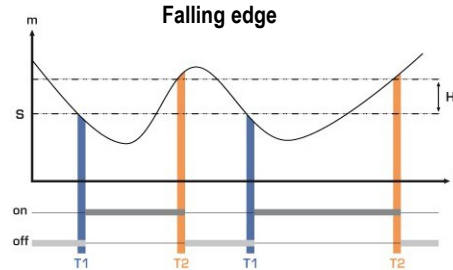

Measurement (m) < Threshold (S) during the time-delay T1 → Alarm activation.

Measurement (m) > Threshold (S) + Hysteresis (H) during time-delay T2 → Alarm deactivation.

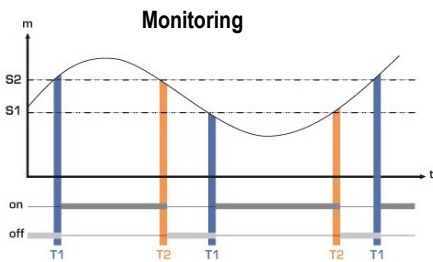

The alarm goes off when the measurement is outside the low and high thresholds.

- > Press briefly on the button to select the trespassing direction then press the button more than 3 seconds to validate this direction and set the thresholds.

• **Set the threshold(s) value**

The first digit blinks, it corresponds to the positive (0) or negative (-) setting of the threshold value. Press briefly on the button to select the sign for the threshold value. Press on the button more than 3 seconds to validate.

The second digit blinks, press briefly on the button to scroll the numbers. Press the button more than 3 seconds to validate.

Repeat the process until the last digit to configure the threshold value, validate the threshold and go to the following setting.

If the monitoring edge has been selected, the transmitter displays the setting of the second threshold.

• **Set the hysteresis**

The hysteresis is only for the rising edge and the falling edge modes.

In rising edge mode, the hysteresis allows to the transmitter to stay in alarm when the measurement is between the threshold and the threshold minus the hysteresis.

Ex : for a 1000 ppm threshold and a 100 ppm hysteresis, the instrument will stay in alarm when the measurement will be between 1000 and 900 ppm.

In falling edge mode, the hysteresis allows to the transmitter to stay in alarm when the measurement is between the threshold and the threshold plus the hysteresis.

Ex : for a 1000 ppm threshold and a 100 ppm hysteresis, the instrument will stay in alarm when the measurement will be between 1000 and 1100 ppm.

The first digit blinks, set it pressing the button briefly several times then press on the button more than 3 seconds to set the following digit.

Once the hysteresis is set, press the button more than 3 seconds to validate and set the time-delays.

• **Set the time-delay 1 and the time-delay 2 (600 seconds maximum)**

- > In rising edge mode, the time-delay 1 corresponds to the time lag before the alarm goes off when the threshold has been reached. The time-delay 2, corresponds to the time lag before the alarm stops when the measurement is lower than the threshold minus the hysteresis.

Setting procedure : “**Time 1**” for the time-delay 1 is displayed then the time in second. The first digit blinks, press briefly on the button and scroll the figures. Press on the button more than 3 seconds to validate. Repeat the process until the last digit to set the time-delay 1 value (from 0 to 600 s) and validate. “**Time 2**” is displayed the the time in second. Repeat the process to set the time-delay 2.

- > In falling edge mode, the time-delay 1 corresponds to the time lag before the alarm goes off when the threshold has been reached. The time-delay 2, corresponds to the time lag before the alarm stops when the measurement is lower than the threshold plus the hysteresis.

The setting procedure is the same as the rising edge procedure.

- > In monitoring mode, the alarm of the transmitter goes off when the measurement is below the lower threshold and higher the high threshold. The time-delay 1 corresponds to the time lag before the alarm goes off when the measurement is below the lower threshold and higher the high threshold. The time-delay 2 corresponds to the time lag before the alarm stops when the measurement is between the lower and higher thresholds.

The setting procedure is the same as the rising edge procedure.

The setting of time delays is done, the measurement is displayed.

LCC ()

PC

DIP

PC

Example : for a 0-500 ppm transmitter, the minimum delta is 20 ppm. So the transmitter could be configure from 0 to 70 ppm from 0 to 20 ppm.

- DIP
- LCC-S
- LCC-S()
- * : 가
- DIP

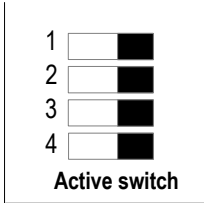

ABS

"A" 30

가 가

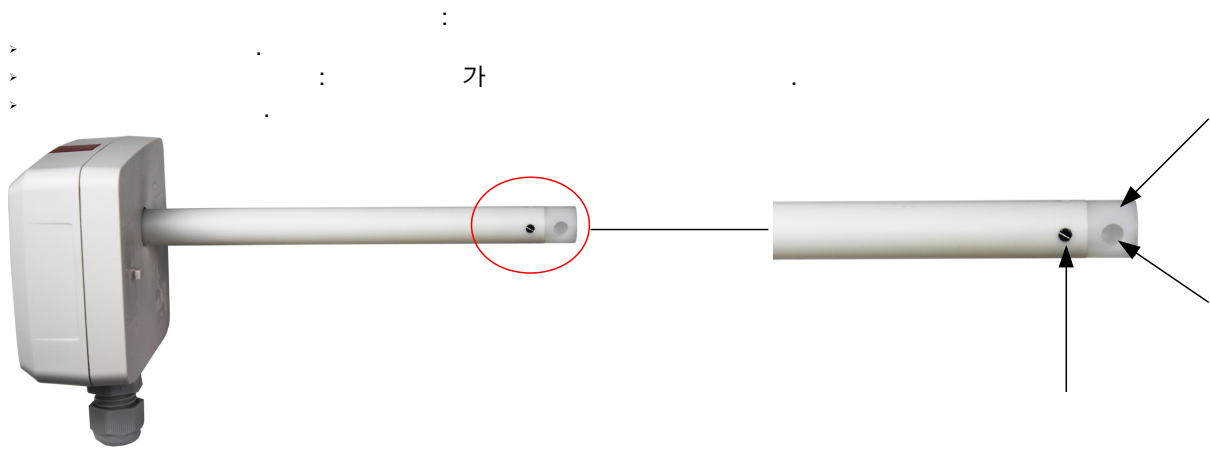
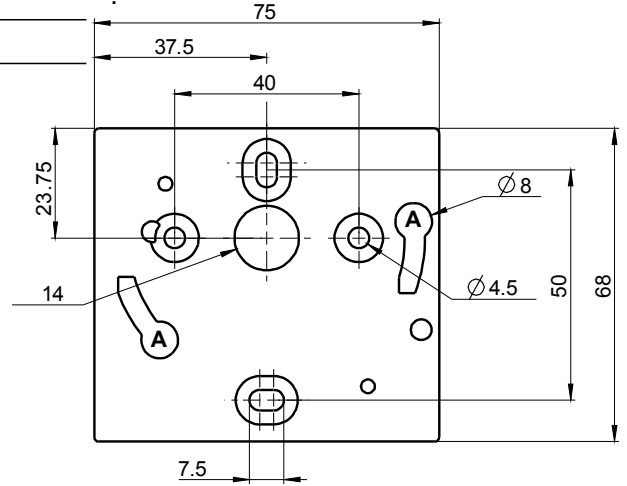

- KIAL-100A : Power supply class 2 , 230 Vac input, 24 Vac output
- LCC-S : configuration software with USB cable

www.kimocorea.com

Distributed by :



EXPROT DEPARTMENT
 Tel : 02-338-0023 Fax : 02-338-0083
 e-mail : kimo@kimocorea.com